

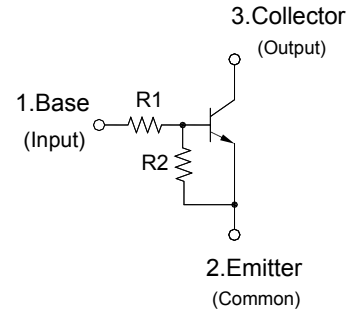

NPN Silicon Epitaxial Planar Digital Transistor

Features

- With built-in bias resistors
- Simplify circuit design
- Reduce a quantity of parts and manufacturing process



MARKING: 24

SOT523

Absolute Maximum Ratings ($T_a = 25^\circ\text{C}$)

Parameter	Symbol	Value	Unit
Collector Emitter Voltage	V_{CEO}	50	V
Input Voltage	V_i	- 10 to + 40	V
Collector Current	I_C	100	mA
Power Dissipation	P_{tot}	150	mW
Junction Temperature	T_j	150	$^\circ\text{C}$
Storage Temperature Range	T_{stg}	- 55 to + 150	$^\circ\text{C}$

Characteristics at $T_a = 25^\circ\text{C}$

Parameter	Symbol	Min.	Typ.	Max.	Unit
DC Current Gain at $V_{CE} = 5\text{ V}$, $I_C = 5\text{ mA}$	h_{FE}	30	-	-	-
Collector Base Cutoff Current at $V_{CB} = 50\text{ V}$	I_{CBO}	-	-	500	nA
Emitter Base Cutoff Current at $V_{EB} = 5\text{ V}$	I_{EBO}	-	-	0.88	mA
Collector Emitter Saturation Voltage at $I_C = 10\text{ mA}$, $I_B = 0.5\text{ mA}$	$V_{CE(sat)}$	-	-	0.3	V
Input on Voltage at $V_{CE} = 0.3\text{ V}$, $I_C = 10\text{ mA}$	$V_{I(on)}$	-	-	3	V
Input off Voltage at $V_{CE} = 5\text{ V}$, $I_C = 100\text{ }\mu\text{A}$	$V_{I(off)}$	0.5	-	-	V
Transition frequency at $V_{CE} = 10\text{ V}$, $-I_E = 5\text{ mA}$, $f = 100\text{ MHz}$	f_T	-	250	-	MHz
Input Resistance	R_1	7	10	13	K Ω
Resistance Ratio	R_2 / R_1	0.8	1	1.2	-

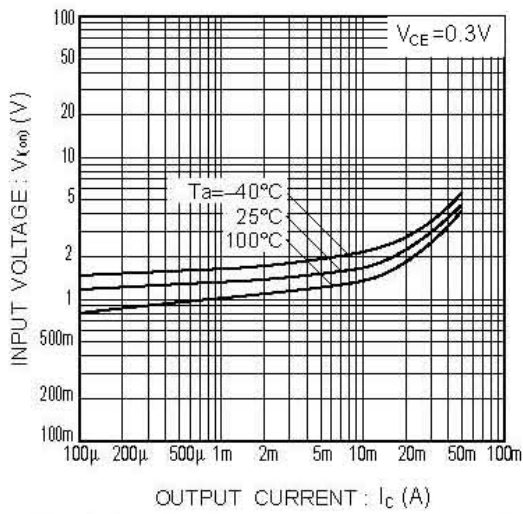

Fig.1 Input voltage vs. output current (ON characteristics)

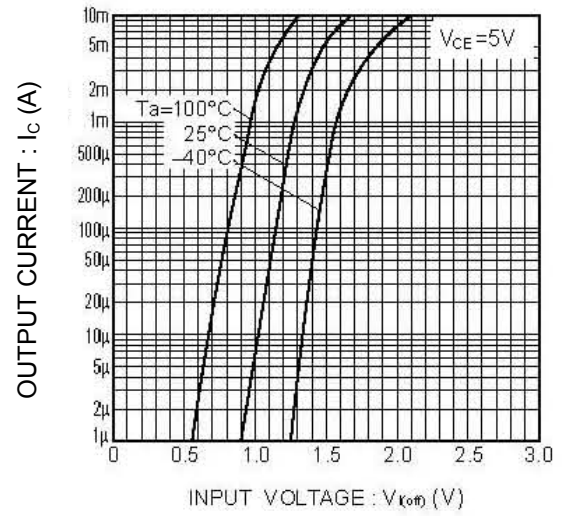

Fig.2 Output current vs. input voltage (OFF characteristics)

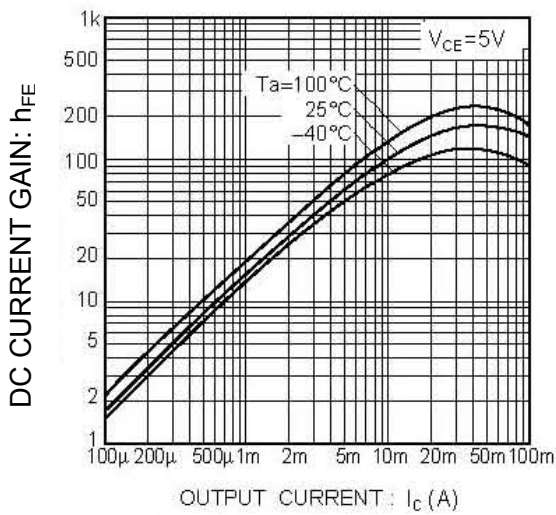

Fig.3 DC current gain vs. output current

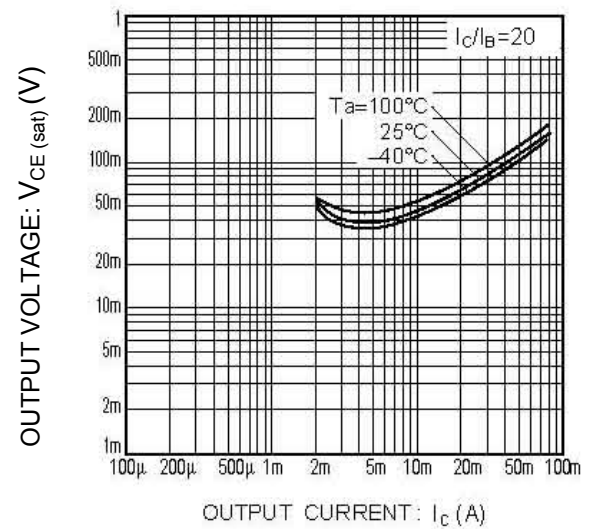
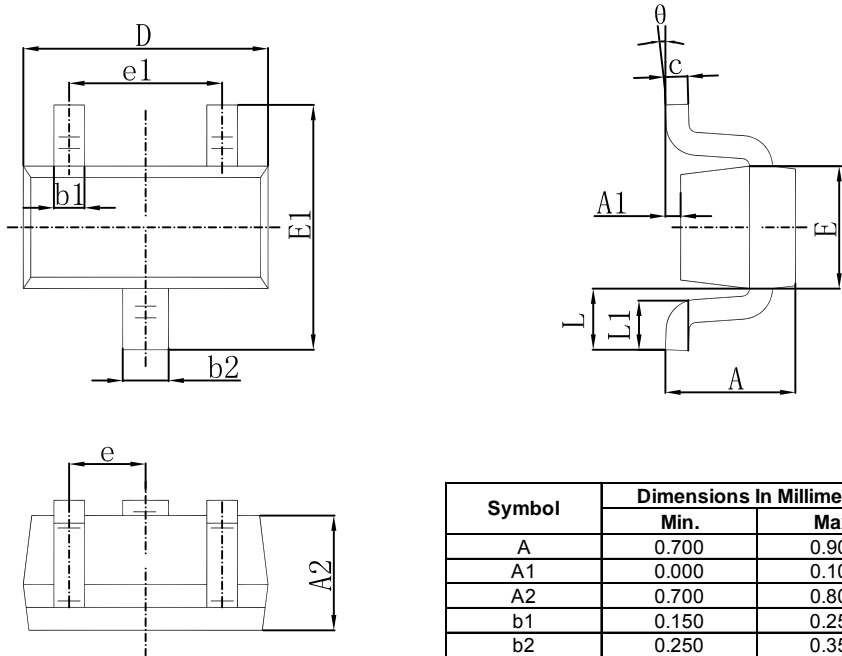

Fig.4 Output voltage vs. output current



SOT-523 Package Outline Dimensions



Symbol	Dimensions In Millimeters		Dimensions In Inches	
	Min.	Max.	Min.	Max.
A	0.700	0.900	0.028	0.035
A1	0.000	0.100	0.000	0.004
A2	0.700	0.800	0.028	0.031
b1	0.150	0.250	0.006	0.010
b2	0.250	0.350	0.010	0.014
c	0.100	0.200	0.004	0.008
D	1.500	1.700	0.059	0.067
E	0.700	0.900	0.028	0.035
E1	1.450	1.750	0.057	0.069
e	0.500 TYP.		0.020 TYP.	
e1	0.900	1.100	0.035	0.043
L	0.400 REF.		0.016 REF.	
L1	0.260	0.460	0.010	0.018
θ	0°	8°	0°	8°

SOT-523 Suggested Pad Layout

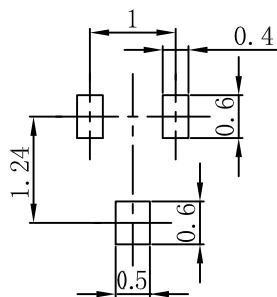

Note:

1. Controlling dimension: in millimeters.
2. General tolerance: $\pm 0.05\text{mm}$.
3. The pad layout is for reference purposes only.